

# 75x<sub>3</sub>

## SPECIFICATIONS

SAE Net Horsepower: 54 HP (40 kW)

Operating Weight: 17,400 lbs. (7 900 kg)

Digging Depth: 13 ft. 7 in. (4.13 m)





## Cab

The Link-Belt X3 cab is the strongest and roomiest LBX has ever offered. The X3 cab is ROPS and FOPS Level 1 certified and is designed to be strong and safe without sacrificing operator comfort. These improvements leave plenty of room to rest work boots on the two foot rests on either side of the travel pedals.

### Roomy

- 8% larger than X2 series cab
- 6% more floor space

### Strong

- ROPS and FOPS Level 1 certified

### Comfortable

- Fully-adjustable KAB seat in the 145 X3 and 235 X3, forward/backward, up/down
- Seat slides independently of console
- Adjustable arm rest angles, lumbar support, suspension

### Optimum Visibility

- Sunroof with sunshade rated FOPS level 1
- Additional mirrors
- Standard rearview camera
- Wiper blade stores off front glass

### Ergonomic Joysticks

- Low-effort
- Pre-wired for auxiliary hydraulics
- Function buttons for wiper swipe, horn, radio mute and one-touch idle
- Large, easy-to-push triggers

### Quiet

- Pressurized cab
- 8% stronger climate control system with 8 vents
- Auxiliary sound jack to enjoy music or podcasts

### Organized

- Logically located switches and controls
- Accessible 12V outlet for cell phone charging
- Cup holder
- Handy phone storage areas
- Removable ashtray; empty space can be used as an additional cup holder





## High-Definition 7" LED Monitor

The Link-Belt X3's from LBX are equipped with an all new High-Definition LED monitor. The full-color 7-inch monitor is one of the largest in the industry and rivals the resolution and quality found in luxury automobiles.

The X3's user-friendly monitor panel includes an engine-idle shutdown option that safely shuts off the engine after 3 minutes of idling, conserving fuel. Another idle feature accessible from the monitor panel is the auto-idle feature that, when selected, takes the engine speed down to an idle level, conserving fuel while waiting for that next truck to show up.



### 145 X3 and 235 X3 Models

The 145 X3 and 235 X3 models use a "passive" regeneration process and the monitor clearly lets the operator know what is going on and if they need to do anything with the machine. The on-screen DPD gauge shows the level of particulate matter that the DPF is capturing and will clean it out every 8 hours by way of an Auto Regeneration. During the Auto Regeneration process, the operator does NOT have to do anything with the machine other than keep working. During a parked, or Manual Regeneration, the monitor will give the operator the appropriate instructions on what to do with the machine, making it as simple as possible.

### In-Cab Control

- Select and set up attachments
- Track or monitor up to 13 service interval reminders
- Engine idle shutdown, which, when selected, safely shuts off the engine after 3 minutes of idling to conserve fuel
- Adjust hydraulic flow
- 18 languages available

### Monitor

- Fuel consumption gauge
- Full color display of standard rear view camera AND optional side-view camera on the same screen
- Monitor engine coolant and hydraulic oil temperatures
- Displays fuel level, travel mode, work mode and attachment mode
- System/Machine warning messages
- Work tool settings



A standard rear-view camera displays a panoramic view of the worksite from the rear of the machine, an optional side-view camera is available.

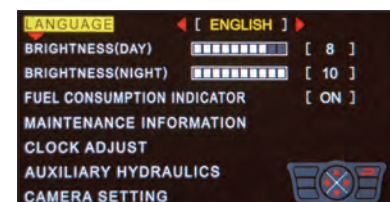

From the Computer Menu, you can change the monitor language, program service reminders and change auxiliary settings for flow to name a few.

## Engine

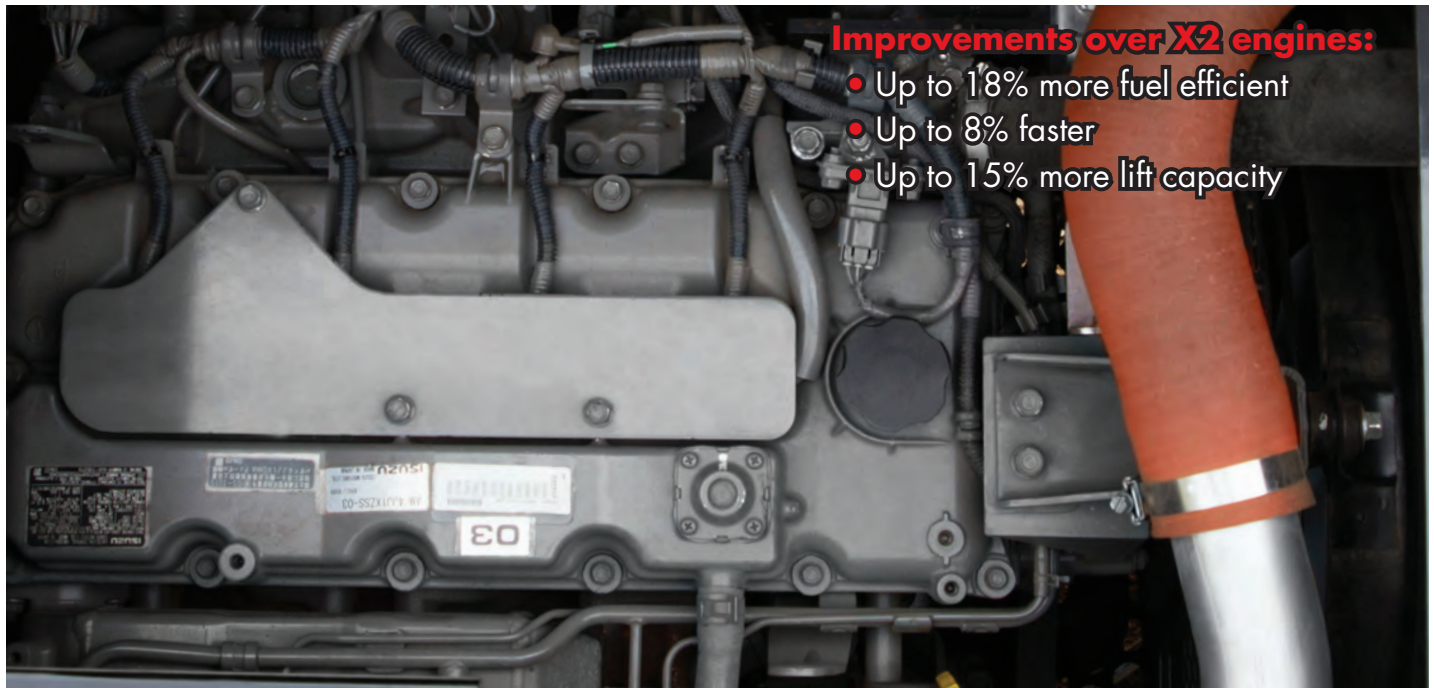

### Improvements over X2 engines:

- Up to 18% more fuel efficient
- Up to 8% faster
- Up to 15% more lift capacity

The fuel-efficient, powerful, productive, quiet and long-lasting Isuzu engine LBX uses in the Link-Belt X3 series meets the EPA's Interim Tier 4 (Tier 4a) requirements by way of cooled exhaust gas recirculation (EGR) technology and a diesel particulate diffuser system (DPD) in the 145 X3 and 235 X3. The DPD consists of a diesel oxidation catalyst (DOC) and a diesel particulate filter (DPF) for "passive regeneration" of exhaust emissions. The 75 X3 and 80 X3 are Final Tier 4-certified and are not equipped with a DPF; therefore, they do not require any regeneration.

A new variable geometry turbocharger (VGT), available on the 145 X3 and 235 X3, helps optimize the combustion process and ensures consistent boost pressure during low engine rpm's. This maintains efficient machine performance and helps eliminate harmful nitrous oxides (NOx) from forming.

The X3 has three engine work modes to give the operator full control of the machine for the job at hand:



- **Speed Priority (SP mode)** is the fastest and most productive mode giving the operator peak machine performance to get the job done quickly.
- **Heavy (H mode)** is a perfect combination of fuel efficiency and productivity. It really is the best of both worlds!
- **Applied Power (A mode)** gives the operator 13 different engine rpm settings to choose from to easily fine tune the machine to the specific job at hand. This mode is perfect for heavy lifting, fine grading or leveling work, and pipeline contractors use it to safely set pipe down into the trench.



### Intelligent Design

- Quiet
- Long-lasting
- One-touch idle and auto idle functions conserve fuel
- Idle start protects a cold engine from over-revving
- Auto engine warm up feature gradually increases engine speed until normal operating temperature is achieved



## Hydraulics

The Link-Belt X3's from LBX are equipped with two Kawasaki variable-displacement axial-piston pumps and one Kawasaki gear pump installed in-line with the engine. This is the most efficient hydraulic pump layout – keeping engine rpm's low while producing plenty of hydraulic muscle.

The X3 uses an open center hydraulic system which refers to the open passage in the control valve that allows the hydraulic oil to return to tank when the control valve is centered. This design gives the machine a much smoother feeling when operating and also eliminates excess pressure throughout the system, which, in turn, helps to conserve fuel.

### Powerful & Productive

- Available on the 145 X3 and 235 X3, Auto Power Boost gives 9% more hydraulic pressure (power) for 8 seconds
- More speed through larger hydraulic lines
- Improved oil regeneration circuits

### Safe

- Boom and arm holding valves
- Standard hydraulic control pattern change valve to move between ISO and SAE
- Optional "Free Swing" auto-centers the machine over the load and takes out the pendulum effect of large, long loads

### Long-lasting

- Continuous filtration of 5000-hour hydraulic oil through a 6 micron, full-flow return filter
- Less wear due to reduced back pressure





## Serviceability

### Easy to maintain

- Ground level access to:
  - ✓ Batteries
  - ✓ Dual fuel filters with water separators
  - ✓ Engine oil filter
  - ✓ Dual element air filter
  - ✓ Cab fresh air filter
- Green drain plug and hose
- Easy-open engine hood
- Easy-access in-cab fuse box accessible while seated in cab seat
- Side-by-side oil cooler/radiator design is easy to clean
- Quick and easy access to grease all attachment pivot points
- Grease cylinder track adjusters make adjusting track tension a breeze

### Maintenance reminders

- In-cab monitor will track 13 different serviceable items:
  - ✓ 5 reminders for engine items
  - ✓ 5 for hydraulic items
  - ✓ 3 other reminders

### Simple

- Flexible and heat-resistant color-coded wiring harnesses
- External fuel site gauge can be viewed from ground-level to see fuel levels
- Lube and maintenance charts posted inside toolbox for readability and protection from the elements

## Performance

### Improvements and Optimizations

- 15% increased lift capacity over previous series
- 18% better fuel efficiency than previous series
- 8% faster cycle times
- Time will be saved in switching out the attachment tools via the in-cab monitor





# Innovation at Work





## Durability

LBX built the Link-Belt X3 series to last, and they come with one of the best standard warranties in the industry. We back our machines with a 1-year / 1,800 hour full machine warranty, a 2-year / 3,000 hour engine warranty, and a 3-year / 10,000 hour XtraStructure warranty that even covers the turntable bearing and tub.



EMS (Extended Maintenance System) chrome pins and grease impregnated brass bushings with graphite inserts reduce wear-and-tear and can be found throughout the attachment. This design makes it possible to extend lube intervals to 6 months or 1,000 hours at all pivot points excluding the bucket which is monthly or 250 hours, whichever comes first.

### Strong

- All booms and arms are ultrasound tested at the factory
- X-Pattern carbody made with high tensile strength steel
- Turntable bearing tub extends through the carbody and is welded on top and bottom
- Factory standard belly pan guard
- D-channel sideframes provide excellent impact resistance
- Cab is FOPS level 1 and ROPS certified
- Thicker steel plating on the attachment
- Standard HD linkage on 350 X3 and 470 X3 and on all Link-Belt X3 excavators ordered with factory hydraulic packages



*X-Pattern carbody*

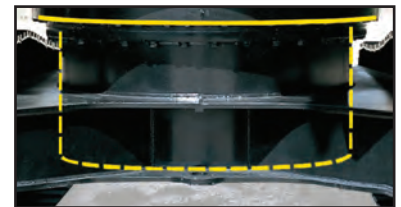

*Turntable bearing tub*

### Options

- Pre-existing mounting bosses make adding additional guarding easy
- Rubber bumper guarding
- Catwalks

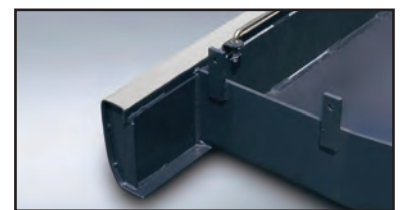

*D-channel sideframes*





# Specifications

## Engine

Isuzu AP-4LE2X Final Tier 4 turbocharged diesel engine with electronic control (ECM) and high pressure common-rail fuel injection, 4-cylinder, Water-cooled, Cooled Exhaust Gas Recirculation (CEGR), Turbocharger, Intercooler, Diesel Oxidation Catalyst (DOC), Electronic fuel pump and priming, Fuel cooler, Auto-idle start, Auto warm-up, EPF engine protection, Dual-stage fuel filtration, In-cab fuel filter restriction indicator, Remote oil filter, Green plug oil drain, Double element air filter, Spark arrest muffler, Battery disconnect switch.

SAE net horsepower..... 54 hp (40 kW) @ 2,000 rpm  
 Displacement..... 133 cu in (2.2 L)  
 Maximum Torque.. 142 lbfft (193 Nm) @ 1,800 rpm  
 Starter ..... 24V-3.2 kW  
 Alternator..... 50 amp  
 Battery..... (2) 12-volt 64 amp hours

## Cab and Controls

ROPS certified cab with climate control A/C and heat with defroster, Control panel with LED Hi-Definition color monitor, Rearview camera display, Fuel-efficiency gauge, Low-effort joysticks pre-wired for auxiliary hydraulics, Control pattern changer, Safety glass windows, Sunroof with sunshade, Shockless cab suspension with four fluid mountings, SCM reclining suspension seat, AM/FM sound system with MP3 auxiliary input jack, Digital clock, Dome light, Seat belt, Coat hook, Cup holder, Storage compartments, Floor mat, Footrests, Ashtray, 24-volt cigarette lighter, 12-volt outlet, Travel alarm, Handrails, Mirrors, Cab light, Side-entry cab filter, Spare parts kit.

Three selectable working modes, Anti-theft password protection system, On-board self-diagnostic system with memory and service interval reminders, Auto-idling system, One-touch decelerator, Auto-idle engine shutdown, Neutral safety start, Gate-lock safety shutoff.

A/C Rating ..... 20,080 BTU/h  
 Heater Rating ..... 21,030 BTU/h  
 Sound Level - Cab Interior..... 72.0 dB(A)  
 Sound Level - Exterior..... 97.0 dB(A)

## Swing

Planetary reduction powered by axial-piston motor, Internal ring gear with grease cavity for swing pinion, Swing bearing is single-row, shear type ball bearing, Mechanical disc swing brake, Auto-power swing.

Swing Speed..... 10.4 rpm  
 Tail Swing ..... 4' 9" (1.29 m)  
 Swing Torque ..... 12,500 lbfft (17.0 kNm)

## Hydraulic System

Open-center system, Two variable-displacement axial-piston pumps and one gear pump for pilot controls, Main control valve with one 4-spool section and one 5-spool section with auxiliary spool, One-spool valve for blade, Auxiliary Control System, Oil cooler, Boom holding valve, 6 micron return filter, Firewall.

### Hydraulic Pumps

Pump Output ..... 2 x 19.6 gpm (74 L/min)  
 Pilot Pump Max. Flow ..... 4.8 gpm (18 L/min)  
 Blade Pump Max. Flow ... 9.4 gpm (35.4 L/min)

### Relief Valve Settings

Boom/Arm/Bucket..... 4,260 psi (29.4 MPa)  
 Swing Circuit..... 3,280 psi (22.6 MPa)  
 Pilot Pump Working

Circuit Pressure..... 570 psi (3.9 MPa)  
 Blade Pump Working

Circuit Pressure..... 3,410 psi (23.5 MPa)  
 Travel Circuit ..... 4,260 psi (29.4 MPa)

### Hydraulic Cylinders

number of cylinders - bore x rod x stroke  
 Boom ..... 1 - 4.5" x 2.9" x 33.5"  
 (115 mm x 75 mm x 850 mm)  
 Arm..... 1 - 3.9" x 2.5" x 29.7"  
 (100 mm x 65 mm x 755 mm)  
 Offset Arm Cylinder ... 1 - 3.7" x 2.4" x 26.9"  
 (95 mm x 60 mm x 685 mm)  
 Offset Cylinder ..... 1 - 3.9" x 2.2" x 12.4"  
 (100 mm x 55 mm x 315 mm)  
 Bucket ..... 1 - 3.3" x 2.2" x 26.2"  
 (85 mm x 55 mm x 665 mm)  
 Blade ..... 1 - 4.3" x 2.8" x 7.1"  
 (110 mm x 70 mm x 180 mm)

## Undercarriage

X Pattern carbody with dozer blade, 6' 2" (1.87 m) track gauge, Sealed and strutted track chain with track guide, Sealed rollers and idlers, Two-speed independent hydrostatic travel with compact planetary final drive, Disc type brakes, Adjustable track tension, Carbody belly pan.

Carrier Rollers ..... 1 per Side  
 Track Rollers ..... 5 per Side  
 Track Link Pitch ..... 6.06" (154 mm)  
 Shoes ..... 39 per Side  
 Shoe Width..... 17.7" (450 mm)

### Ground Pressure

Mono Boom..... 5.08 psi (0.35 Bar)  
 Offset Boom..... 5.37 psi (0.37 Bar)

## Travel System

Two-speed independent hydrostatic travel with compact axial-piston motors, Hydraulic motor powered output shaft coupled to a planetary reduction drive and track sprocket, All hydraulic components mounted within the width of side frame, Automatic downshift for high torque to overcome obstacles, Spring-applied hydraulic release parking brake built into each motor, Travel motors equipped with counterbalance valve to prevent over-speeding down an incline.

Travel Speeds... 2.0 - 3.2 mph (3.2 - 5.1 km/h)  
 Drawbar Pull ..... 13,400 lbf (59.5 kN)  
 Gradeability..... 70% (35°)

## Attachment

Boom ..... 12' 4" (3.75 m)  
 Offset Boom ..... 12' 9" (3.89 m)

### Available Arms (Excavator) Digging Force

• 5' 7" (1.69 m) ..... 8,880 lbf (39.5 kN)  
 • 7' 2" (2.19 m) ..... 7,600 lbf (33.8 kN)

### Available Arms (Offset) Digging Force

• 5' 9" (1.75 m) ..... 8,860 lbf (39.4 kN)  
 • 6' 11" (2.10 m) ..... 7,800 lbf (34.7 kN)  
 Bucket Digging Force.... 12,800 lbf (56.9 kN)

## Lubricant and Coolant Capacity

Fuel Tank..... 31.7 Gallons (120.0 Liters)  
 Hydraulic System ... 25.4 Gallons (96.3 Liters)  
 Hydraulic Tank..... 13.5 Gallons (51.0 Liters)  
 Final Drive (per side)... 0.3 Gallons (1.1 Liters)  
 Engine Oil..... 3.0 Gallons (11.5 Liters)  
 Coolant System..... 3.2 Gallons (12.2 Liters)

## Operating Weight

**Mono Boom Excavator** - Working weight with blade, 17.7" (450 mm) shoes, 12' 4" (3.75 m) boom, 5' 7" (1.69 m) arm, 460 lb. (210 kg) bucket, 2,140 lbs (970 kg) counterweight ..... 17,400 lbs. (7 900 kg)

**Offset Boom Excavator** - Working weight with blade, 17.7" (450 mm) shoes, 12' 9" (3.89 m) boom, 5' 9" (1.75 m) arm, 460 lb. (210 kg) bucket, 2,140 lbs (970 kg) counterweight ..... 18,300 lbs. (8 280 kg)



## Working Ranges

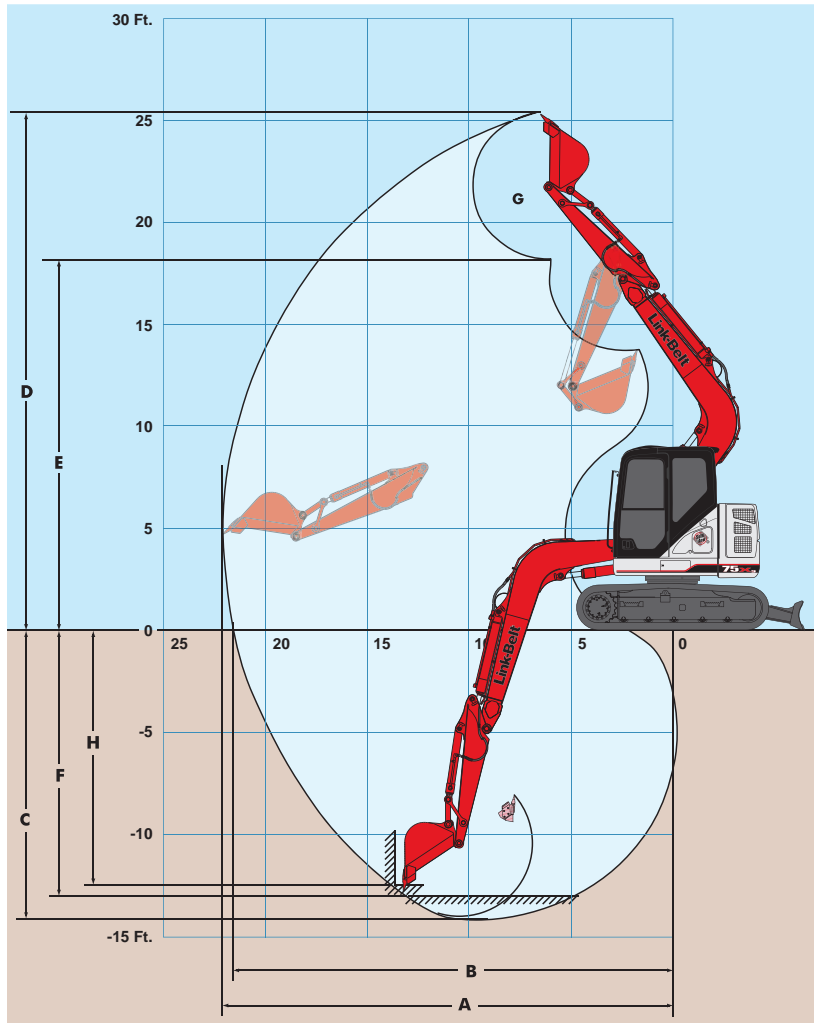

Machine Equipped with 12' 4" (3.75 m) Boom	Arm 5' 7" (1.69 m)	Arm 7' 2" (2.19 m)
A. Maximum reach	21' 0" (6.41 m)	22' 7" (6.89 m)
B. Maximum reach @ ground level	20' 7" (6.27 m)	22' 2" (6.76 m)
C. Maximum dig depth	13' 7" (4.13 m)	15' 2" (4.63 m)
D. Maximum dig height	24' 2" (7.37 m)	25' 6" (7.77 m)
E. Maximum dump height	17' 4" (5.28 m)	18' 7" (5.67 m)
F. Digging depth 8' (2.44 m) level bottom	12' 6" (3.80 m)	14' 4" (4.36 m)
G. Bucket rotation	177°	177°
H. Maximum vertical wall depth	11' 11" (3.64 m)	13' 9" (4.20 m)

## Blade Dimensions

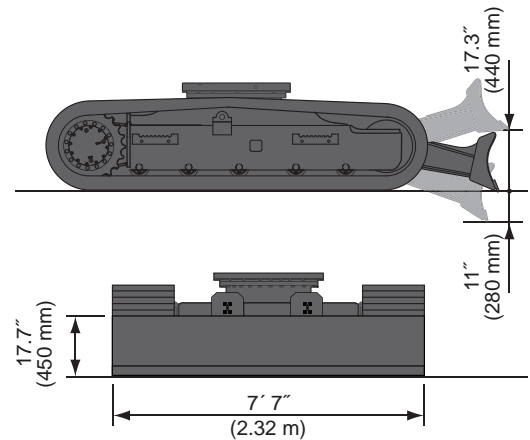

## Travel Dimensions

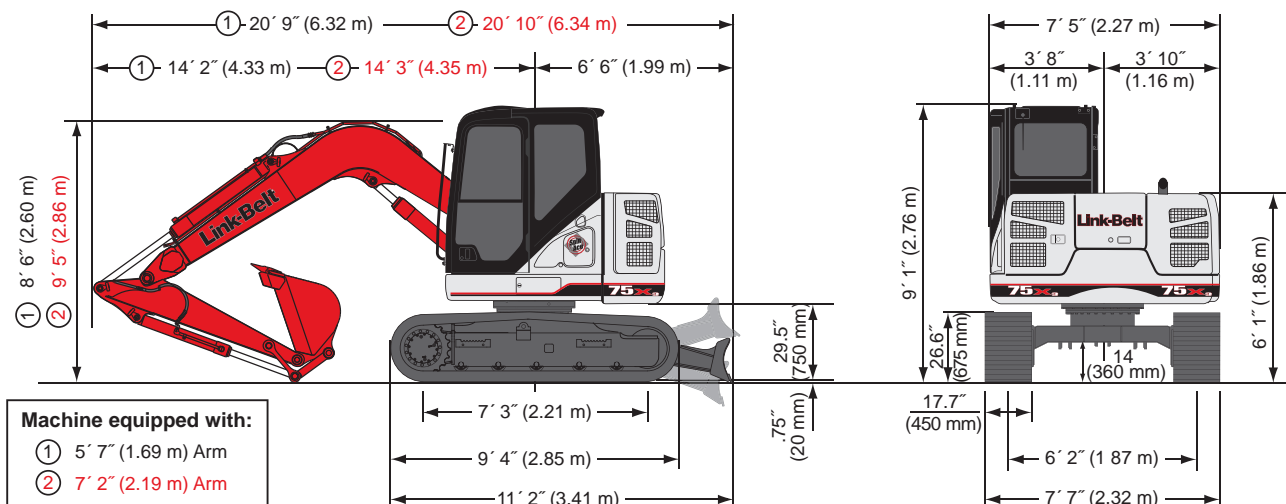



## Working Ranges

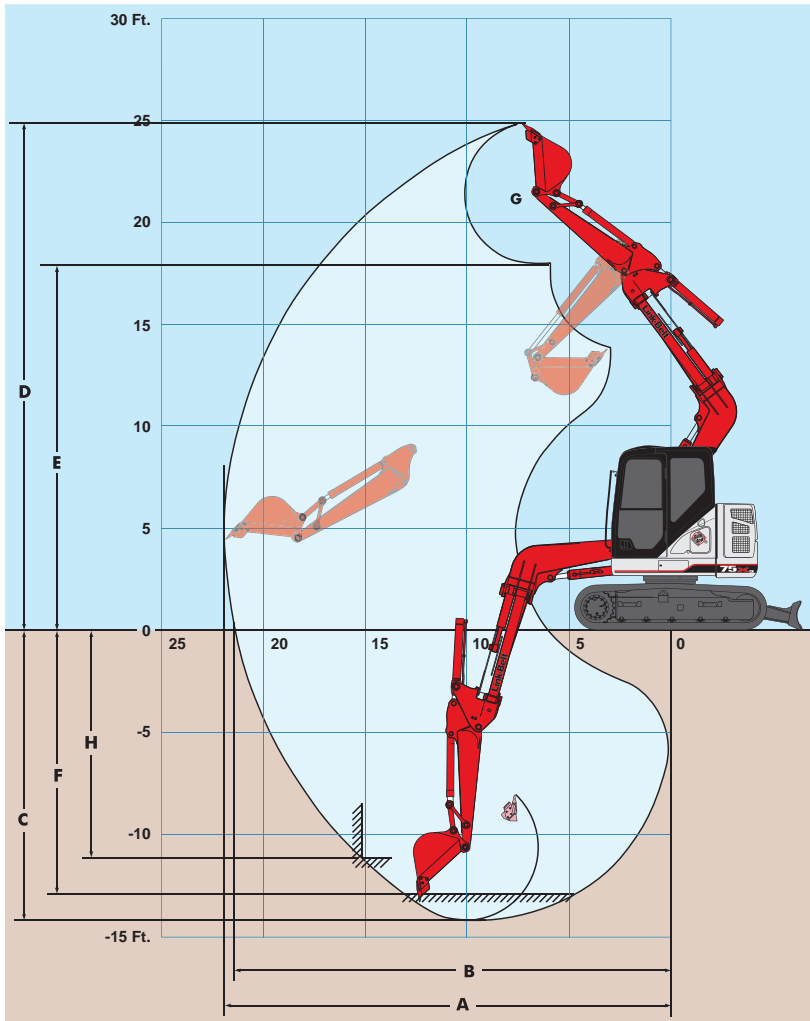

Machine Equipped with 12' 9" (3.89 m) Boom	Arm 5' 9" (1.75 m)	Arm 6' 11" (2.10 m)
A. Maximum reach	21' 4" (6.50 m)	22' 3" (6.79 m)
B. Maximum reach @ ground level	20' 10" (6.36 m)	21' 10" (6.66 m)
C. Maximum dig depth	13' 11" (4.25 m)	15' 1" (4.60 m)
D. Maximum dig height	24' 3" (7.38 m)	24' 11" (7.59 m)
E. Maximum dump height	17' 5" (5.31 m)	18' 1" (5.52 m)
F. Digging depth 8' (2.44 m) level bottom	12' 8" (3.87 m)	13' 11" (4.25 m)
G. Bucket rotation	177°	177°
H. Maximum vertical wall depth	10' 11" (3.33 m)	12' 1" (3.68 m)

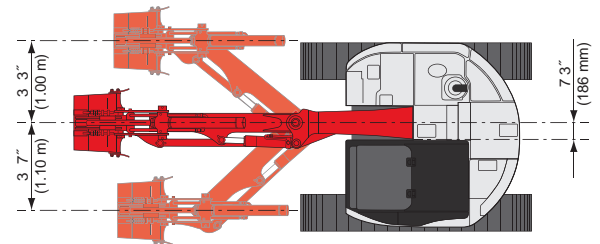



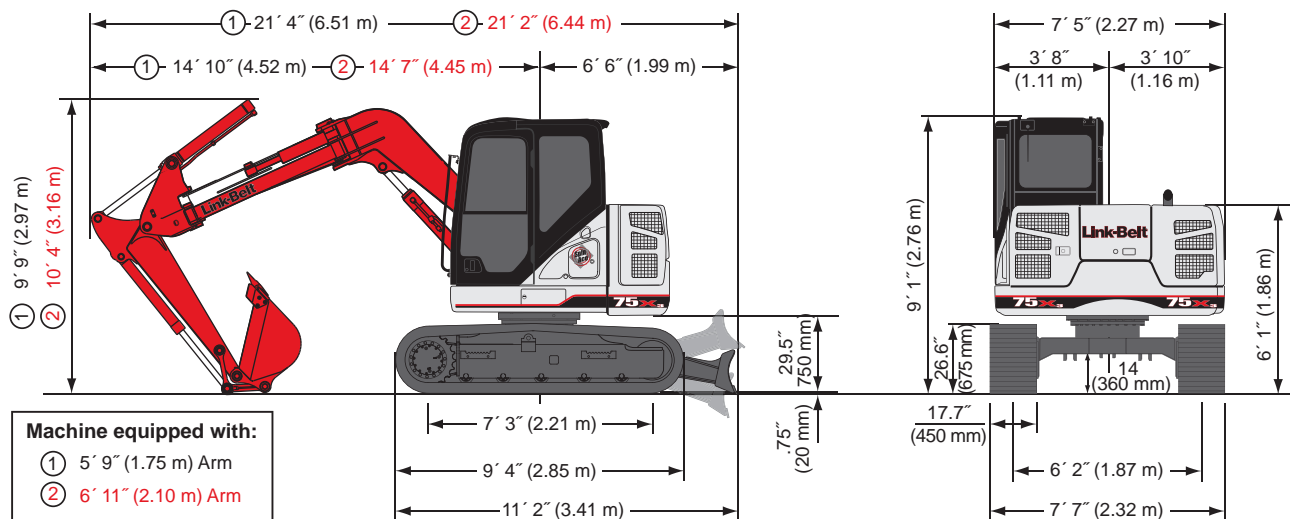

















## Travel Dimensions





## Lifting Capacities - ISO Ratings

Radius of Load - Mono Boom with Blade Down										
5' 7" (1.69 m) Arm with 12' 4" (3.75 m) Boom and 450 lb. (210 kg) Bucket with Power-Boost Applied										
	5' 0" (1.5 m)		10' 0" (3.0 m)		15' 0" (4.5 m)		20' 0" (6.0 m)		Cap at Max. Reach	
	 End	 Side	 End	 Side	 End	 Side	 End	 Side	 End	 Side
<b>+20' 0"</b> lbs			3,750*	3,750*					2,700*	2,700*
(6.0 m) kg			1 690*	1 690*					1 210*	1 210*
<b>+15' 0"</b> lbs			4,050*	4,050*	3,650*	3,450			2,300*	2,300*
(4.5 m) kg			1 850*	1 850*	1 690*	1 600			1 050*	1 050*
<b>+10' 0"</b> lbs	8,300*	8,300*	5,500*	5,500*	4,150*	3,300			2,250*	2,050
(3.0 m) kg	3 910*	3 910*	2 560*	2 560*	1 910*	1 540			1 030*	930
<b>+5' 0"</b> lbs			7,350*	5,950	4,850*	3,100	2,950*	1,900	2,400*	1,900
(1.5 m) kg			3 380*	2 770	2 230*	1 450	1 620*	890	1 090*	850
<b>Ground Line</b> lbs			8,000*	5,550	5,050*	2,950			2,750*	1,950
kg			3 690*	2 570	2 340*	1 370			1 250*	890
<b>-5' 0"</b> lbs	8,250*	8,250*	7,450*	5,450	4,700*	2,900			3,600*	2,400
(1.5 m) kg	3 660*	3 660*	3 440*	2 550	2 180*	1 350			1 630*	1 080
<b>-10' 0"</b> lbs	8,600*	8,600*	5,150*	5,150*					3,400*	3,400*
(3.0 m) kg	4 030*	4 030*	2 430*	2 430*					1 560*	1 560*

Radius of Load - Mono Boom with Blade Up										
5' 7" (1.69 m) Arm with 12' 4" (3.75 m) Boom and 450 lb. (210 kg) Bucket with Power-Boost Applied										
	5' 0" (1.5 m)		10' 0" (3.0 m)		15' 0" (4.5 m)		20' 0" (6.0 m)		Cap at Max. Reach	
	 End	 Side	 End	 Side	 End	 Side	 End	 Side	 End	 Side
<b>+20' 0"</b> lbs			3,750*	3,750*					2,700*	2,700*
(6.0 m) kg			1 690*	1 690*					1 210*	1 210*
<b>+15' 0"</b> lbs			4,050*	4,050*	3,600	3,300			2,300*	2,300*
(4.5 m) kg			1 850*	1 850*	1 670	1 540			1 050*	1 050*
<b>+10' 0"</b> lbs	8,300*	8,300*	5,500*	5,500*	3,500	3,150			2,150	1,950
(3.0 m) kg	3 910*	3 910*	2 560*	2 560*	1 620	1 470			970	880
<b>+5' 0"</b> lbs			6,400	5,700	3,250	2,950	2,000	1,850	1,950	1,800
(1.5 m) kg			2 970	2 640	1 520	1 380	940	850	890	810
<b>Ground Line</b> lbs			5,950	5,250	3,100	2,800			2,050	1,850
kg			2 760	2 440	1 440	1 300			930	850
<b>-5' 0"</b> lbs	8,250*	8,250*	5,850	5,200	3,050	2,750			2,500	2,300
(1.5 m) kg	3 660*	3 660*	2 740	2 420	1 420	1 290			1 130	1 030
<b>-10' 0"</b> lbs	8,600*	8,600*	5,150*	5,150*					3,400*	3,400*
(3.0 m) kg	4 030*	4 030*	2 430*	2 430*					1 560*	1 560*























## Lifting Capacities - ISO Ratings

Radius of Load - Mono Boom with Blade Down												
7' 2" (2.19 m) Arm with 12' 4" (3.75 m) Boom and 450 b. (210 kg) Bucket with Power-Boost Applied												
	0' 0" (0.0 m)		5' 0" (1.5 m)		10' 0" (3.0 m)		15' 0" (4.5 m)		20' 0" (6.0 m)		Cap at Max. Reach	
	End	Side	End	Side	End	Side	End	Side	End	Side	End	Side
<b>+20' 0"</b> lbs											2,300*	2,300*
(6.0 m) kg											1 020*	1 020*
<b>+15' 0"</b> lbs							3,500*	3,450*			2,000*	2,000*
(4.5 m) kg							1 570*	1 570*			900*	900*
<b>+10' 0"</b> lbs					4,400*	4,400*	3,800*	3,400	3,200*	2,050	1,950*	1,800
(3.0 m) kg					2 030*	2 030*	1 730*	1 580	1 500*	950	890*	820
<b>+5' 0"</b> lbs					6,750*	6,150	4,600*	3,200	3,550*	1,950	2,050*	1,700
(1.5 m) kg					3 100*	2 860	2 130*	1 480	1 630*	910	940*	760
<b>Ground</b> lbs			4,150*	4,150*	7,950*	5,600	5,050*	3,000	3,600*	1,900	2,350*	1,750
<b>Line</b> kg			1 840*	1 840*	3 680*	2 610	2 330*	1 380	1 670*	870	1 060*	790
<b>-5' 0"</b> lbs	4,750*	4,750*	7,100*	7,100*	7,750*	5,450	4,950*	2,900			2,950*	2,050
(1.5 m) kg	2 140*	2 140*	3 160*	3 160*	3 580*	2 530	2 280*	1 340			1 330*	920
<b>-10' 0"</b> lbs			10,950*	10,950*	6,150*	5,500	3,400*	2,900			3,400*	2,900
(3.0 m) kg			5 110*	5 110*	2 880*	2 560	1 670*	1 380			1 540*	1 310

Radius of Load - Mono Boom with Blade Up												
7' 2" (2.19 m) Arm with 12' 4" (3.75 m) Boom and 450 b. (210 kg) Bucket with Power-Boost Applied												
	0' 0" (0.0 m)		5' 0" (1.5 m)		10' 0" (3.0 m)		15' 0" (4.5 m)		20' 0" (6.0 m)		Cap at Max. Reach	
	End	Side	End	Side	End	Side	End	Side	End	Side	End	Side
<b>+20' 0"</b> lbs											2,300*	2,300*
(6.0 m) kg											1 020*	1 020*
<b>+15' 0"</b> lbs							3,500*	3,350			2,000*	2,000*
(4.5 m) kg							1 570*	1 540			900*	900*
<b>+10' 0"</b> lbs					4,400*	4,400*	3,550*	3,250	2,150	1,950	1,900	1,750
(3.0 m) kg					2 030*	2 030*	1 660	1 520	1 000	910	860	780
<b>+5' 0"</b> lbs					6,500	5,850	3,350	3,050	2,050	1,850	1,750	1,600
(1.5 m) kg					3 030	2 730	1 560	1 410	960	870	800	720
<b>Ground</b> lbs			4,150*	4,150*	6,000	5,350	3,150	2,850	1,950	1,800	1,800	1,650
<b>Line</b> kg			1 840*	1 840*	2 800	2 480	1 460	1 320	920	830	820	750
<b>-5' 0"</b> lbs	4,750*	4,750*	7,100*	7,100*	5,850	5,150	3,050	2,750			2,150	1,950
(1.5 m) kg	2 140*	2 140*	3 160*	3 160*	2 720	2 400	1 410	1 280			970	880
<b>-10' 0"</b> lbs			10,950*	10,950*	5,900	5,250	3,100	2,800			3,100	2,800
(3.0 m) kg			5 110*	5 110*	2 740	2 450*	1 440	1 320			1 380	1 250

## Lifting Capacities - ISO Ratings

Radius of Load - Offset Boom with Blade Down										
5' 9" (1.75 m) Arm with 12' 9" (3.89 m) Offset Boom and 460 lb. (210 kg) Bucket with Power-Boost Applied										
	5' 0" (1.5 m)		10' 0" (3.0 m)		15' 0" (4.5 m)		20' 0" (6.0 m)		Cap at Max. Reach	
	 End	 Side	 End	 Side	 End	 Side	 End	 Side	 End	 Side
<b>+20' 0"</b> lbs			3,550*	3,550*					3,350*	3,350*
(6.0 m) kg			1 600*	1 600*					1 510*	1 510*
<b>+15' 0"</b> lbs			3,800*	3,800*	3,450*	3,350			3,150*	2,450
(4.5 m) kg			1 750*	1 750*	1 600*	1 550			1 420*	1 080
<b>+10' 0"</b> lbs			4,850*	4,850*	3,750*	3,200			3,150*	1,800
(3.0 m) kg			2 260*	2 260*	1 730*	1 480			1 420*	820
<b>+5' 0"</b> lbs			6,450*	5,500	4,400*	2,850	3 250*	1 700	3,200*	1,600
(1.5 m) kg			2 980*	2 550	2 020*	1 330	1,500*	790	1 440*	730
<b>Ground Line</b> lbs			7,200*	4,850	4,550*	2,600			3,250*	1,650
kg			3 310*	2 260	2 110*	1 200			1 460*	740
<b>-5' 0"</b> lbs	7,500*	7,500*	6,700*	4,800	4,250*	2,500			3,250*	2,000
(1.5 m) kg	3 360*	3 360*	3 090*	2 230	1 980*	1 160			1 480*	900
<b>-10' 0"</b> lbs	7,750*	7,750*	4,800*	4,800*					3,200*	3,200*
(3.0 m) kg	3 630*	3 630*	2 240*	2 240*					1 460*	1 420

Radius of Load - Offset Boom with Blade Up										
5' 9" (1.75 m) Arm with 12' 9" (3.89 m) Offset Boom and 460 lb. (210 kg) Bucket with Power-Boost Applied										
	5' 0" (1.5 m)		10' 0" (3.0 m)		15' 0" (4.5 m)		20' 0" (6.0 m)		Cap at Max. Reach	
	 End	 Side	 End	 Side	 End	 Side	 End	 Side	 End	 Side
<b>+20' 0"</b> lbs			3,550*	3,550*					3,350*	3,350*
(6.0 m) kg			1 600*	1 600*					1 510*	1 510*
<b>+15' 0"</b> lbs			3,800*	3,800*	3,450*	3,250*			2,550	2,350
(4.5 m) kg			1 750*	1 750*	1 600*	1 500			1 140	1 030
<b>+10' 0"</b> lbs			4,850*	4,850*	3,350	3,050			1,900	1,700
(3.0 m) kg			2 260*	2 260*	1 570	1 420			870	780
<b>+5' 0"</b> lbs			5,950	5,250	3,050	2,700	1,800	1,600	1,700	1,500
(1.5 m) kg			2 760	2 420	1 410	1 270	830	750	770	680
<b>Ground Line</b> lbs			5,250	4,600	2,750	2,450			1,750	1,550
kg			2 450	2 130	1 280	1 140			790	700
<b>-5' 0"</b> lbs	7,500*	7,500*	5,200	4,500	2,650	2,350			2,100	1,900
(1.5 m) kg	3 360*	3 360*	2 410	2 100	1 240	1 100			950	850
<b>-10' 0"</b> lbs	7,750*	7,750*	4,800*	4,650*					3,200*	3,050
(3.0 m) kg	3 630*	3 630*	2 240*	2 160					1 460*	1 340



## Lifting Capacities - ISO Ratings

Radius of Load - Offset Boom with Blade Down										
6' 11" (2.10 m) Arm with 12' 9" (3.89 m) Offset Boom and 400 lb. (190 kg) Bucket with Power-Boost Applied										
	5' 0" (1.5 m)		10' 0" (3.0 m)		15' 0" (4.5 m)		20' 0" (6.0 m)		Cap at Max. Reach	
	End	Side	End	Side	End	Side	End	Side	End	Side
<b>+20' 0"</b> lbs			2,800*	2,800*					3,000*	3,000*
(6.0 m) kg			1 210*	1 210*					1 330*	1 330*
<b>+15' 0"</b> lbs			3,350*	3,350*	3,250*	3,250*			2,750*	2,200
(4.5 m) kg			1 530*	1 530*	1 470*	1 470*			1 240*	980
<b>+10' 0"</b> lbs			4,400*	4,400*	3,500*	3,300	3,000*	1,850	2,750*	1,700
(3.0 m) kg			2 030*	2 030*	1 620*	1 530	1 370*	870	1 260*	760
<b>+5' 0"</b> lbs			6,050*	5,700	4,250*	2,900	3,200*	1,700	2,950*	1,500
(1.5 m) kg			2 800*	2 650	1 960*	1 360	1 470*	800	1 350*	670
<b>Ground</b> lbs			7,050*	4,900	4,550*	2,600	3,200*	1,600	3,050*	1,500
<b>Line</b> kg			3 250*	2 290	2 100*	1 210	1 490*	740	1 380*	680
<b>-5' 0"</b> lbs	6,900*	6,900*	6,850*	4,700	4,400*	2,450			3,100*	1,750
(1.5 m) kg	3 070*	3 070*	3 170*	2 190	2 030*	1 140			1 420*	800
<b>-10' 0"</b> lbs	9,200*	9,200*	5,350*	4,850					3,200*	2,650
(3.0 m) kg	4 290*	4 290*	2 500*	2 260					1 460*	1 180

Radius of Load - Offset Boom with Blade Up										
6' 11" (2.10 m) Arm with 12' 9" (3.89 m) Offset Boom and 400 lb. (190 kg) Bucket with Power-Boost Applied										
	5' 0" (1.5 m)		10' 0" (3.0 m)		15' 0" (4.5 m)		20' 0" (6.0 m)		Cap at Max. Reach	
	End	Side	End	Side	End	Side	End	Side	End	Side
<b>+20' 0"</b> lbs			2,800*	2,800*					3,000*	3,000*
(6.0 m) kg			1 210*	1 210*					1 330*	1 330*
<b>+15' 0"</b> lbs			3,350*	3,350*	3,250*	3,200*			2,300	2,100
(4.5 m) kg			1 530*	1 530*	1 470*	1 470*			1 040	940
<b>+10' 0"</b> lbs			4,400*	4,400*	3,450	3,150	1,950	1,750	1,750	1,600
(3.0 m) kg			2 030*	2 030*	1 600*	1 460	920	830	800	720
<b>+5' 0"</b> lbs			6,050*	5,450	3,100	2,800	1,800	1,600	1,550	1,400
(1.5 m) kg			2 800	2 510	1 440	1 290	850	760	710	630
<b>Ground</b> lbs			5,350	4,650	2,750	2,450	1,700	1,500	1,600	1,400
<b>Line</b> kg			2 480	2 160	1 290	1 150	790	700	720	640
<b>-5' 0"</b> lbs	6,900*	6,900*	5,100	4,450	2,600	2,300			1,900	1,650
(1.5 m) kg	3 070*	3 070*	2 380	2 060	1 220	1 080			850	750
<b>-10' 0"</b> lbs	9,200*	9,200*	5,200	4,600					2,850	2,500
(3.0 m) kg	4 290*	4 290*	2 420*	2 140					1 260	1 120

### Notes: Excavator lifting capacities

- Lifting capacities shown should not be exceeded. Weight of all lifting accessories must be deducted from the above lifting capacities.
- Lifting capacities are based on machine standing on firm, uniform supporting surface. User must make allowances for job conditions such as soft or uneven ground.
- Lifting capacities shown do not exceed 75% of minimum tipping loads or 87% of hydraulic capacities. Capacities marked with an asterisk (\*) are limited by hydraulic capacities.
- Least stable position is over the side.
- Operator should be fully acquainted with the Operator's Manual & Operating Safety Booklet, furnished by LBX before operating the machine.
- Capacities apply only to the machine as originally manufactured and normally equipped by LBX Company, LLC.
- Lift capacity ratings are based on ISO 10567, "Earthmoving Machinery - Hydraulic Excavators - Lift Capacity."

## Standard and Optional Equipment

<p><b>CAB</b></p> <ul style="list-style-type: none"> <li>12V Power Outlet ..... ✓</li> <li>AM/FM Sound System ..... ✓</li> <li>Anti-Theft Device ..... ✓</li> <li>Auxiliary Switches on Control Lever ..... ✓</li> <li>Cab Exterior Light Harness ..... ✓</li> <li>Cab Filter - External ..... ✓</li> <li>Cab Handrails ..... ✓</li> <li>Cab Interior Light ..... ✓</li> <li>Cab Iso-Mounts ..... ✓</li> <li>Cab Light (1) ..... ✓</li> <li>Cab Light (Additional) ..... ●</li> <li>Clear Roof Window ..... ✓</li> <li>Climate Control A/C and Heater ..... ✓</li> <li>Cup Holder ..... ✓</li> <li>Defroster ..... ✓</li> <li>Digital Clock ..... ✓</li> <li>ECO Gauge ..... ✓</li> <li>Emergency Exit and Hammer ..... ✓</li> <li>Face Vent ..... ✓</li> <li>Floor Mat ..... ✓</li> <li>FOPS Level 1 Certified ..... ✓</li> <li>FOPS Head Guard (Level 2) ..... ●</li> <li>Front Guard (Mesh) ..... ●</li> <li>Front Guard (OPG 1,2) ..... ●</li> <li>Front Window One-Touch Lock ..... ✓</li> <li>Gate Lock Hydraulic Activation ..... ✓</li> <li>Horn ..... ✓</li> <li>Hour Meter (Digital) ..... ✓</li> <li>LED Color Monitor ..... ✓</li> <li>Magazine Storage Rack ..... ✓</li> <li>Maintenance Interval Reminders ..... ✓</li> <li>MP3 Auxiliary Input Jack ..... ✓</li> <li>On-Board Diagnostic System ..... ✓</li> <li>One-Piece Right Window ..... ✓</li> <li>Radio Mute Switch ..... ✓</li> <li>Rear View Camera ..... ✓</li> <li>Rear View Mirrors ..... ✓</li> <li>Roof Sun Shade ..... ✓</li> <li>ROPS Certified ..... ✓</li> <li>Safety Glass Windows ..... ✓</li> <li>SCM Suspension Seat ..... ✓</li> <li>Seat Recline ..... ✓</li> <li>Selectable Monitor Languages ..... ✓</li> <li>Small Storage ..... ✓</li> <li>Travel Alarm with Cancel Switch ..... ✓</li> <li>Trip Meter (Digital) ..... ✓</li> <li>Wiper &amp; Washer ..... ✓</li> <li>Wiper Switch on RH Joystick ..... ✓</li> </ul> <p><b>ENGINE</b></p> <ul style="list-style-type: none"> <li>Air Filter (Double Element) ..... ✓</li> <li>Air Filter Restriction Indicator ..... ✓</li> <li>Auto Warm-Up System ..... ✓</li> <li>Auto-Idle ..... ✓</li> <li>Auto-Idle Engine Shutdown ..... ✓</li> <li>Battery Disconnect Switch ..... ✓</li> <li>CEGR (Cooled Exhaust Gas Recirculation) ..... ✓</li> <li>Cooling Fan ..... ✓</li> <li>Diesel Oxidation Catalyst (DOC) ..... ✓</li> </ul>	<ul style="list-style-type: none"> <li>Drain for Fuel Tank ..... ✓</li> <li>Dual Remote Fuel Filters with Water Separators ..... ✓</li> <li>EGR Cooler ..... ✓</li> <li>Emergency Engine Stop ..... ✓</li> <li>Engine Idle System ..... ✓</li> <li>Engine Protection Feature ..... ✓</li> <li>Fan Housing ..... ✓</li> <li>Fuel Cooler ..... ✓</li> <li>Fuel Filter Restriction Indicator ..... ✓</li> <li>Fuel Management System ..... ✓</li> <li>Fuel Shut-Off Valve ..... ✓</li> <li>Fuel Usage Monitor ..... ✓</li> <li>Glow Plug Pre-Heat ..... ✓</li> <li>Idle-Start ..... ✓</li> <li>Intercooler ..... ✓</li> <li>Neutral Start ..... ✓</li> <li>One-Touch Idle ..... ✓</li> <li>Radiator / Oil Cooler Protective Screen ..... ✓</li> <li>Remote Engine Oil Drain ..... ✓</li> <li>Remote Oil Filter ..... ✓</li> <li>Spark Arrestor Muffler ..... ✓</li> <li>Turbocharger with Heat Shield ..... ✓</li> </ul> <p><b>HYDRAULICS</b></p> <ul style="list-style-type: none"> <li>Arm Regeneration ..... ✓</li> <li>Arm Speed Assistance (2 Pump Flow) ..... ✓</li> <li>Attachment Cushion Valve ..... ✓</li> <li>Auto Swing Priority ..... ✓</li> <li>Auxiliary Flow Control ..... ✓</li> <li>Auxiliary Tool Settings (Memory) ..... ✓</li> <li>Auxiliary Valve ..... ✓</li> <li>Boom Regeneration ..... ✓</li> <li>Boom Speed Assistance (2 Pump Flow) ..... ✓</li> <li>Bucket Curl Assist ..... ✓</li> <li>Control Levers Pre-Wired for Auxiliary Hyd. ..... ✓</li> <li>Control Pattern Changer (2 way) ..... ✓</li> <li>Fire Wall ..... ✓</li> <li>Holding Valve (Boom) ..... ✓</li> <li>Hose Burst Check Valve ..... ●</li> <li>Hydraulic Filter Restriction Indicator ..... ✓</li> <li>Long Life Hydraulic Oil (5,000 Hour) ..... ✓</li> <li>Neutral Pump De-Stroke ..... ✓</li> <li>Oil Cooler ..... ✓</li> <li>Pump Stand-By Pressure ..... ✓</li> </ul> <p><b>AUXILIARY HYDRAULIC OPTIONS - MONO BOOM</b></p> <ul style="list-style-type: none"> <li>Single-Acting Aux. with Pedal Activation ..... ●</li> <li>Single-Acting Aux. with Proportional Joysticks ..... ●</li> <li>Multi-Function Aux. with Proportional Joysticks ..... ●</li> <li>Thumb Aux. with Proportional Joysticks ..... ●</li> <li>Secondary Aux. with Proportional Joysticks ..... ●</li> <li>Combination Aux. with Proportional Joysticks ..... ●</li> </ul> <p><b>AUXILIARY HYDRAULIC OPTIONS - OFFSET BOOM</b></p> <ul style="list-style-type: none"> <li>Single-Acting Aux. with Pedal Activation ..... ●</li> <li>Single-Acting Aux. with Proportional Joysticks ..... ●</li> <li>Double-Acting Aux. with Proportional Joysticks ..... ●</li> </ul>	<p><b>UNDERCARRIAGE</b></p> <ul style="list-style-type: none"> <li>450 mm (17.7" in) Rubber pads (bolts directly to rail) ..... ●</li> <li>450 mm (17.7" in) Rubber pads (bolts to 450 mm grousers) ..... ●</li> <li>450 mm (17.7" in) 3-Bar Steel Grousers ..... ●</li> <li>600 mm (23.5" in) 3-Bar Steel Grousers ..... ●</li> <li>4 Lashing Points (Tie-Downs) ..... ✓</li> <li>7' 7" (2.32 m) Hydraulically Controlled Dozer Blade ..... ✓</li> <li>Carbody Belly Pan (Swivel Guarding) ..... ✓</li> <li>Sealed Link Chain ..... ✓</li> <li>Steps ..... ✓</li> <li>Strutted Track Chain ..... ✓</li> <li>Track Roller Guide (Single) ..... ✓</li> <li>X-Pattern Carbody ..... ✓</li> </ul> <p><b>UPPERSTRUCTURE</b></p> <ul style="list-style-type: none"> <li>Belly Pans ..... ✓</li> <li>Center Cover (Over Main CV) ..... ✓</li> <li>Fuel Tank Belly Pan ..... ✓</li> <li>Lockable Fuel Cap and Service Doors ..... ✓</li> <li>Lockable Tool Box ..... ✓</li> <li>Turntable Tub ..... ✓</li> <li>Work Lights (Boom and Cab) ..... ✓</li> </ul> <p><b>ATTACHMENT</b></p> <ul style="list-style-type: none"> <li>Auxiliary Pipe Brackets ..... ✓</li> <li>Boom Work Light ..... ✓</li> <li>Bucket Anti-Clatter Device ..... ✓</li> <li>Chrome Pins ..... ✓</li> <li>Easy Maintenance System (EMS) ..... ✓</li> <li>HD Bucket Linkage ..... ●</li> <li>Quick Couplers ..... ●</li> <li>Remote Lube Bank ..... ✓</li> <li>Teardrop Pin Retention Keepers ..... ✓</li> <li>Thumbs ..... ●</li> </ul> <p><b>ATTACHMENT OPTIONS - MONO BOOM</b></p> <ul style="list-style-type: none"> <li>5' 7" (1.69 m) Arm ..... ●</li> <li>7' 2" (2.19 m) Arm ..... ●</li> <li>12' 4" (3.75 m) Main Boom Section ..... ✓</li> </ul> <p><b>ATTACHMENT OPTIONS - OFFSET BOOM</b></p> <ul style="list-style-type: none"> <li>5' 9" (1.75 m) Arm ..... ●</li> <li>6' 11" (2.10 m) Arm ..... ●</li> <li>12' 9" (3.89 m) Main Boom Section ..... ✓</li> </ul> <p><b>PARTS KIT</b></p> <ul style="list-style-type: none"> <li>Bucket Anti-Clatter Device ..... ✓</li> <li>Engine Manual ..... ✓</li> <li>Engine Oil Filter ..... ✓</li> <li>Filter Wrench ..... ✓</li> <li>Fuel Filters ..... ✓</li> <li>Grease Gun ..... ✓</li> <li>Green Plug Drain Hose for Engine Oil Drain ..... ✓</li> <li>Hydraulic Return Filter ..... ✓</li> <li>Ignition Keys ..... ✓</li> <li>Pilot Circuit Hydraulic Filter ..... ✓</li> </ul>
---	---	---

**Equipment Key**  
 Standard ✓      Optional ●

## Bucket Sizes

Bucket Type	SAE Heaped Capacity (yd <sup>3</sup> ) (m <sup>3</sup> )		Width Outside Lip (in) (mm)		Bucket Weight (lbs) (kg)		Number of Teeth	Mono Boom		Offset Boom	
								Arm Length		Arm Length	
								5' 7" (1.69 m)	7' 2" (2.19 m)	5' 9" (1.75 m)	6' 11" (2.10 m)
STDP Standard duty plate	.24	.18	18	457	403	183	3	H	H	H	H
	.35	.27	24	610	473	215	4	H	H	H	H
	.45	.34	30	762	542	246	5	H	M	M	L
POWER	.24	.18	18	457	644	292	3	H	H	H	H
	.34	.26	24	610	728	330	4	H	H	H	M
	.45	.34	30	762	812	368	4	M	M	L	L
	.55	.42	36	914	897	407	5	L	L	N/A	N/A
	.65	.50	42	1067	981	445	6	L	N/A	N/A	N/A
DITCH	.61	.47	42	1067	596	270	0	M	L	L	N/A
	.71	.54	48	1219	645	293	0	L	N/A	N/A	N/A

STDP - Standard duty plate  
 HDP - Heavy duty plate  
 XDP - Extreme duty plate  
 POWER - HDP for use with ESCO multi-pin grabber only

**Approval Code For Arm/Bucket Combinations**

H ..... Heavy material (up to 3,370 lbs./yd<sup>3</sup>)  
 M ..... Medium material (up to 2,700 lbs./yd<sup>3</sup>)  
 L ..... Light material (up to 2,020 lbs./yd<sup>3</sup>)  
 N/A ..... Not applicable